

# DS36277

## Dominant Mode Multipoint Transceiver

### General Description

The DS36277 Dominant Mode Multipoint Transceiver is designed for use on bi-directional differential busses. It is optimal for use on Interfaces that utilize Society of Automotive Engineers (SAE) J1708 Electrical Standard.

The device is similar to standard TIA/EIA-485 transceivers, but differs in enabling scheme. The Driver's Input is normally externally tied LOW, thus providing only two states: Active (LOW), or Disabled (OFF). When the driver is active, the dominant mode is LOW, conversely, when the driver is disabled, the bus is pulled HIGH by external bias resistors.

The receiver provides a FAILSAFE feature that guarantees a known output state when the Interface is in the following conditions: Floating Line, Idle Line (no active drivers), and Line Fault Conditions (open or short). The receiver output is HIGH for the following conditions: Open Inputs, Terminated Inputs (50Ω), or Shorted Inputs. FAILSAFE is a highly desirable feature when the transceivers are used with Asynchronous Controllers such as UARTs.

### Features

- FAILSAFE receiver, RO = HIGH for:
  - OPEN inputs
  - Terminated inputs
  - SHORTED inputs
- Optimal for use in SAE J1708 Interfaces
- Compatible with popular interface standards:
  - TIA/EIA-485 and TIA/EIA-422-A
  - CCITT recommendation V.11
- Bi-directional transceiver
  - Designed for multipoint transmission
- Wide bus common mode range
  - (-7V to +12V)
- Available in plastic DIP and SOIC packages

### Connection and Logic Diagram

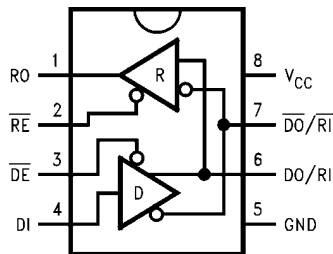

1138401  
 Order Number DS36277TM or DS36277TN  
 See NS Package Number M08A or N08E

### Truth Table

Driver			
Inputs		Outputs	
$\overline{DE}$	DI	DO/RI	$\overline{DO}/\overline{RI}$
L	L	L	H
L	H	H	L
H	X	Z	Z

Receiver		
Inputs	Output	
$\overline{RE}$	DO/RI- $\overline{DO}/\overline{RI}$	RO
L	$\geq 0$ mV	H
L	$\leq -500$ mV	L
L	SHORTED	H
L	OPEN	H
H	X	Z

**Absolute Maximum Ratings** (Note 1)

If Military/Aerospace specified devices are required, please contact the National Semiconductor Sales Office/ Distributors for availability and specifications.

Supply Voltage ( $V_{CC}$ )	7V
Input Voltage ( $\overline{DE}$ , RE, and DI)	5.5V
Driver Output Voltage/	
Receiver Input Voltage	-10V to +15V
Receiver Output Voltage (RO)	5.5V
Maximum Package Power Dissipation @ +25°C	
N Package (derate 9.3 mW/°C above +25°C)	1168 mW
M Package (derate 5.8 mW/°C above +25°C)	726 mW

Storage Temperature Range	-65°C to +150°C
Lead Temperature (Soldering 4 sec.)	260°C
ESD Rating (HBM, 1.5 kΩ, 100 pF)	7.0 kV

**Recommended Operating Conditions**

	Min	Max	Units
Supply Voltage, $V_{CC}$	4.75	5.25	V
Bus Voltage	-7	+12	V
Operating Temperature ( $T_A$ )			
DS36277T	-40	+85	°C

**Electrical Characteristics** (Notes 2, 4)

Over recommended Supply Voltage and Operating Temperature ranges, unless otherwise specified.

Symbol	Parameter	Conditions	Min	Typ	Max	Units		
<b>DRIVER CHARACTERISTICS</b>								
$V_{OD}$	Differential Output Voltage	$I_O = 0$ mA (No Load)	1.5	3.6	6	V		
$V_{oDO}$	Output Voltage	$I_O = 0$ mA (Output to GND)	0		6	V		
$V_{o\overline{DO}}$	Output Voltage		0		6	V		
$V_{T1}$	Differential Output Voltage (Termination Load)	$R_L = 54\Omega$ (485)	(Figure 1)		1.3	2.2	5.0	V
		$R_L = 100\Omega$ (422)			1.7	2.6	5.0	V
$\Delta V_{T1}$	Balance of $V_{T1}$ $ V_{T1} - \overline{V_{T1}} $	$R_L = 54\Omega$	(Note 3)		-0.2		0.2	V
		$R_L = 100\Omega$			-0.2		0.2	V
$V_{OS}$	Driver Common Mode Output Voltage	$R_L = 54\Omega$	(Figure 1)		0	2.5	3.0	V
		$R_L = 100\Omega$			0	2.5	3.0	V
$\Delta V_{OS}$	Balance of $V_{OS}$ $ V_{OS} - \overline{V_{OS}} $	$R_L = 54\Omega$	(Note 3)		-0.2		0.2	V
		$R_L = 100\Omega$			-0.2		0.2	V
$V_{OH}$	Output Voltage High	$I_{OH} = -22$ mA	(Figure 2)		2.7	3.7		V
$V_{OL}$	Output Voltage Low	$I_{OL} = +22$ mA			1.3	2		V
$I_{OSD}$	Driver Short-Circuit Output Current	$V_O = +12V$	(Figure 3)			92	290	mA
		$V_O = -7V$				-187	-290	mA
<b>RECEIVER CHARACTERISTICS</b>								
$V_{TH}$	Differential Input High Threshold Voltage (Note 5)	$V_O = V_{OH}$ , $I_O = -0.4$ mA $-7V \leq V_{CM} \leq +12V$			-0.150	0		V
$V_{TL}$	Differential Input Low Threshold Voltage (Note 5)	$V_O = V_{OL}$ , $I_O = 8.0$ mA $-7V \leq V_{CM} \leq +12V$	-0.5		-0.230			V
$V_{HST}$	Hysteresis (Note 6)	$V_{CM} = 0V$			80			mV
$I_{IN}$	Line Input Current ( $V_{CC} = 4.75V, 5.25V, 0V$ )	Other Input = 0V	$V_I = +12V$			0.5	1.5	mA
		$\overline{DE} = V_{IH}$ (Note 7)	$V_I = -7V$			-0.5	-1.5	mA
$I_{OSR}$	Short Circuit Current	$V_O = 0V$	RO		-15	-32	-85	mA
$I_{OZ}$	TRI-STATE® Leakage Current	$V_O = 0.4$ to $2.4V$			-20	1.4	+20	μA
$V_{OH}$	Output High Voltage (Figure 12)	$V_{ID} = 0V$ , $I_{OH} = -0.4$ mA			2.3	3.7		V
		$V_{ID} = OPEN$ , $I_{OH} = -0.4$ mA			2.3	3.7		V
$V_{OL}$	Output Low Voltage (Figure 12)	$V_{ID} = -0.5V$ , $I_{OL} = +8$ mA				0.3	0.7	V
		$V_{ID} = -0.5V$ , $I_{OL} = +16$ mA			0.3	0.8	V	
$R_{IN}$	Input Resistance				10	20		kΩ

Symbol	Parameter	Conditions	Min	Typ	Max	Units
<b>DEVICE CHARACTERISTICS</b>						
$V_{IH}$	High Level Input Voltage		2.0		$V_{CC}$	V
$V_{IL}$	Low Level Input Voltage		GND		0.8	V
$I_{IH}$	High Level Input Current	$V_{IH} = 2.4V$			20	$\mu A$
$I_{IL}$	Low Level Input Current	$V_{IL} = 0.4V$			-100	$\mu A$
$V_{CL}$	Input Clamp Voltage	$I_{CL} = -18 mA$		-0.7	-1.5	V
$I_{CC}$	Output Low Voltage	$\overline{DE} = 0V, \overline{RE} = 0V, DI = 0V$		39	60	mA
$I_{CCR}$	Supply Current	$\overline{DE} = 3V, \overline{RE} = 0V, DI = 0V$		24	50	mA
$I_{CCD}$	(No Load)	$\overline{DE} = 0V, \overline{RE} = 3V, DI = 0V$		40	75	mA
$I_{CCX}$		$\overline{DE} = 3V, \overline{RE} = 3V, DI = 0V$		27	45	mA

## Switching Characteristics (Note 4)

Over recommended Supply Voltage and Operating Temperature ranges, unless otherwise specified.

Symbol	Parameter	Conditions	Min	Typ	Max	Units
<b>DRIVER CHARACTERISTICS</b>						
$t_{PLHD}$	Diff. Prop. Delay Low to High	$R_L = 54\Omega$	8	17	60	ns
$t_{PHLD}$	Diff. Prop. Delay High to Low	$C_L = 50 pF$	8	19	60	ns
$t_{SKD}$	Diff. Skew ( $t_{PLHD} - t_{PHLD}$ )	$C_D = 50 pF$		2	10	ns
$t_r$	Diff. Rise Time	(Figures 4, 5)		11	60	ns
$t_f$	Diff. Fall Time			11	60	ns
$t_{PLH}$	Prop. Delay Low to High	$R_L = 27\Omega, C_L = 15 pF$		22	85	ns
$t_{PHL}$	Prop. Delay High to Low	(Figures 6, 7)		25	85	ns
$t_{PZH}$	Enable Time Z to High	$R_L = 110\Omega$		25	60	ns
$t_{PZL}$	Enable Time Z to Low	$C_L = 50 pF$		30	60	ns
$t_{PHZ}$	Disable Time High to Z	(Figure 8 – Figure 11)		16	60	ns
$t_{PLZ}$	Disable Time Low to Z			11	60	ns
<b>RECEIVER CHARACTERISTICS</b>						
$t_{PLH}$	Prop. Delay Low to High	$V_{ID} = -1.5V \text{ to } +1.5V$	15	37	90	ns
$t_{PHL}$	Prop. Delay High to Low	$C_L = 15 pF$	15	43	90	ns
$t_{SK}$	Skew ( $t_{PLH} - t_{PHL}$ )	(Figures 13, 14)		6	15	ns
$t_{PZH}$	Enable Time Z to High	$C_L = 15 pF$		12	60	ns
$t_{PZL}$	Enable Time Z to Low	(Figures 15, 16)		28	60	ns
$t_{PHZ}$	Disable Time High to Z			20	60	ns
$t_{PLZ}$	Disable Time Low to Z			10	60	ns

**Note 1:** "Absolute Maximum Ratings" are those values beyond which the safety of the device cannot be guaranteed. They are not meant to imply that the devices should be operated at these limits. The tables of "Electrical Characteristics" specify conditions for device operation.

**Note 2:** Current into device pins is defined as positive. Current out of device pins is defined as negative. All voltages are referenced to ground unless otherwise specified.

**Note 3:**  $\Delta IV_{T1}$  and  $\Delta IV_{OS}$  are changes in magnitude of  $V_{T1}$  and  $V_{OS}$ , respectively, that occur when the input changes state.

**Note 4:** All typicals are given for  $V_{CC} = 5.0V$  and  $T_A = +25^\circ C$ .

**Note 5:** Threshold parameter limits specified as an algebraic value rather than by magnitude.

**Note 6:** Hysteresis defined as  $V_{HST} = V_{TH} - V_{TL}$ .

**Note 7:**  $I_{IN}$  includes the receiver input current and driver TRI-STATE leakage current.

# Parameter Measurement Information

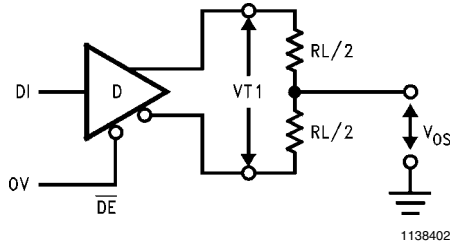

FIGURE 1. Driver  $V_{T1}$  and  $V_{OS}$  Test Circuit

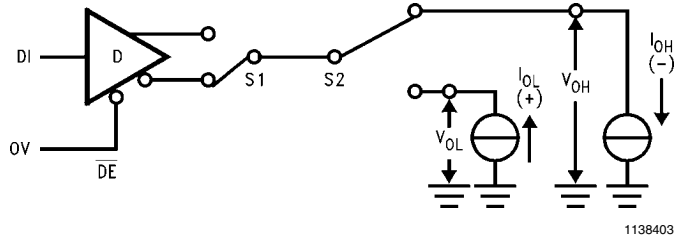

FIGURE 2. Driver  $V_{OH}$  and  $V_{OL}$  Test Circuit

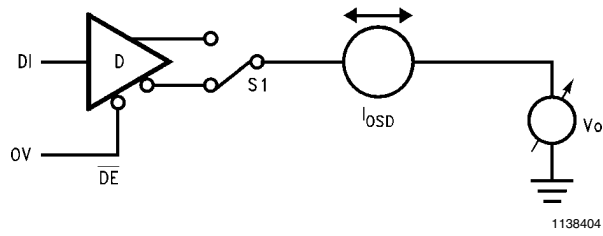

FIGURE 3. Driver Short Circuit Test Circuit

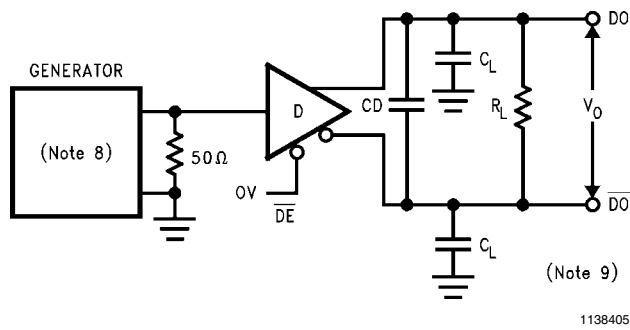

FIGURE 4. Driver Differential Propagation Delay and Transition Time Test Circuit

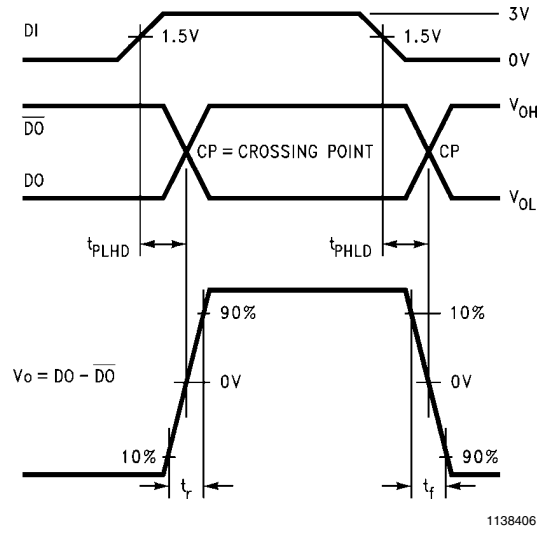

FIGURE 5. Driver Differential Propagation Delays and Transition Times

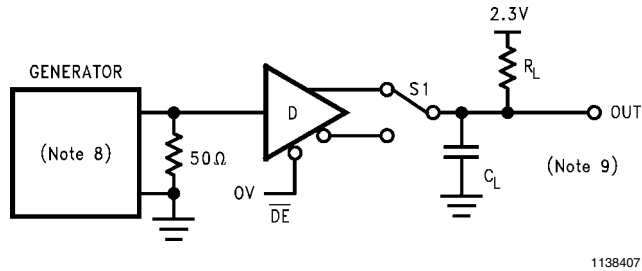

FIGURE 6. Driver Propagation Delay Test Circuit

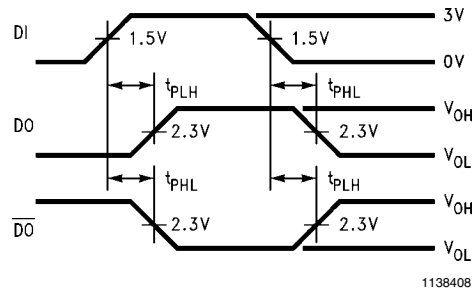
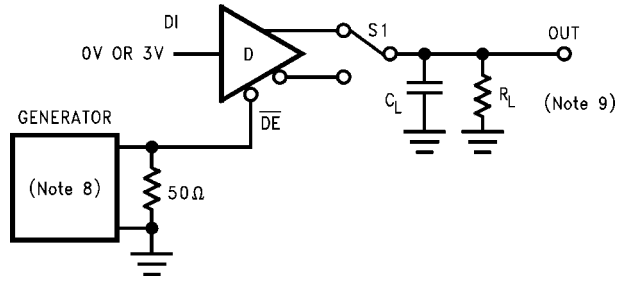

FIGURE 7. Driver Propagation Delays



1138409

S1 to DO for DI = 3V  
S1 to  $\overline{DO}$  for DI = 0V

FIGURE 8. Driver TRI-STATE Test Circuit ( $t_{pZH}$ ,  $t_{pHZ}$ )

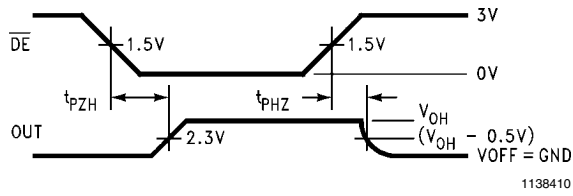

1138410

FIGURE 9. Driver TRI-STATE Delays ( $t_{pZH}$ ,  $t_{pHZ}$ )

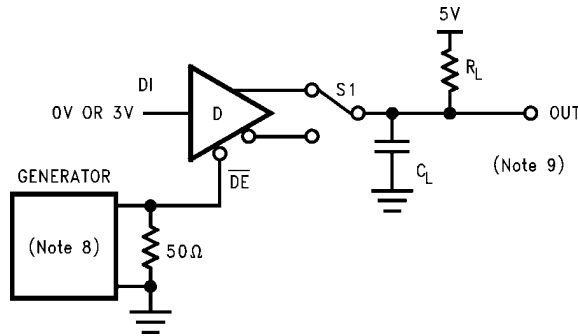

1138411

S1 to DO for DI = 0V  
S1 to  $\overline{DO}$  for DI = 3V

FIGURE 10. Driver TRI-STATE Test Circuit ( $t_{pZL}$ ,  $t_{pLZ}$ )

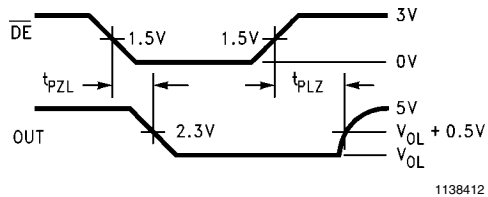

1138412

FIGURE 11. Driver TRI-STATE Delays ( $t_{pZL}$ ,  $t_{pLZ}$ )

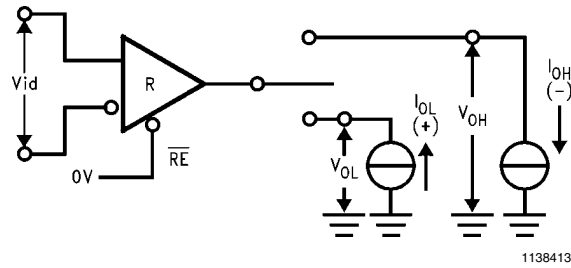

FIGURE 12. Receiver  $V_{OH}$  and  $V_{OL}$

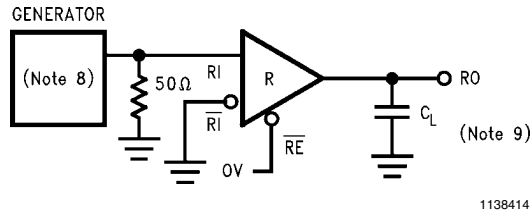

FIGURE 13. Receiver Propagation Delay Test Circuit

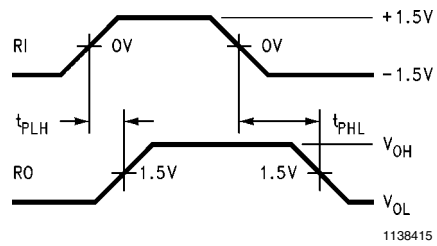

FIGURE 14. Receiver Propagation Delays

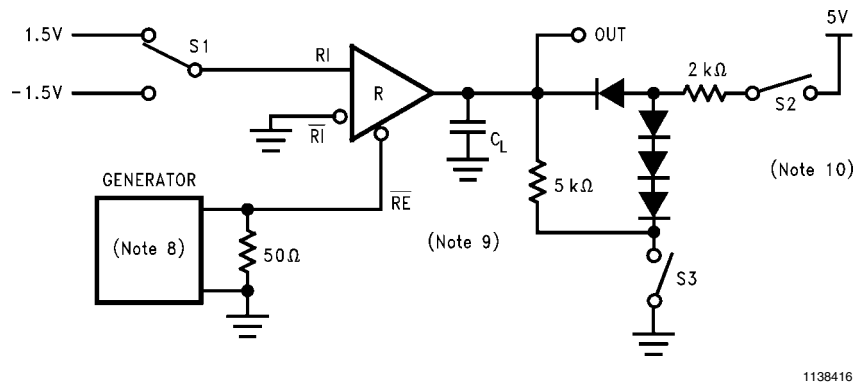
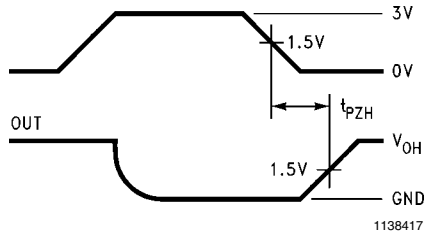
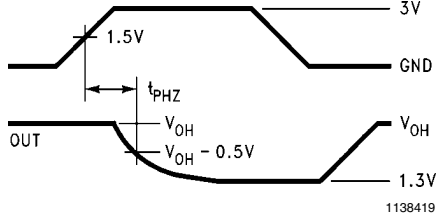

FIGURE 15. Receiver TRI-STATE Delay Test Circuit

S1 1.5V  
S2 OPEN  
S3 CLOSED



S1 1.5V  
S2 CLOSED  
S3 CLOSED



S1 -1.5V  
S2 CLOSED  
S3 OPEN

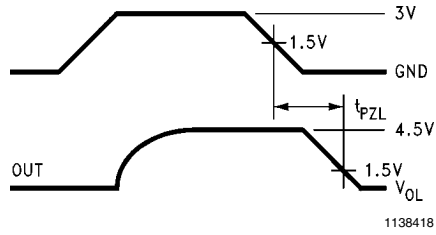

S1 -1.5V  
S2 CLOSED  
S3 CLOSED

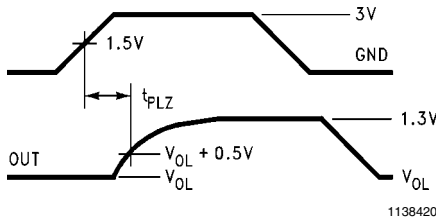

**FIGURE 16. Receiver Enable and Disable Timing**

**Note 8:** The input pulse is supplied by a generator having the following characteristics:  $f = 1.0 \text{ MHz}$ , 50% duty cycle,  $t_r$  and  $t_f < 6.0 \text{ ns}$ ,  $Z_O = 50\Omega$ .

**Note 9:**  $C_L$  includes probe and stray capacitance.

**Note 10:** Diodes are 1N916 or equivalent.



# Typical Performance Characteristics

Differential Output Voltage vs Output Current

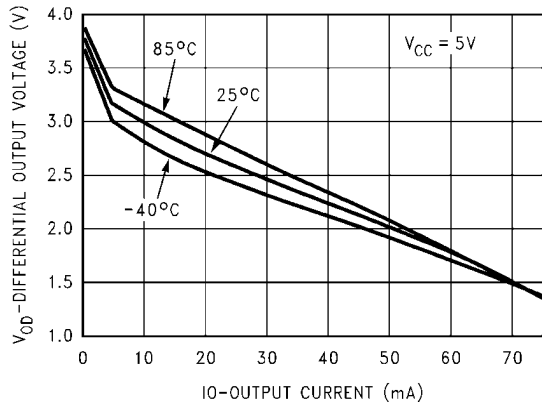

1138422

Differential Output Voltage vs Output Current

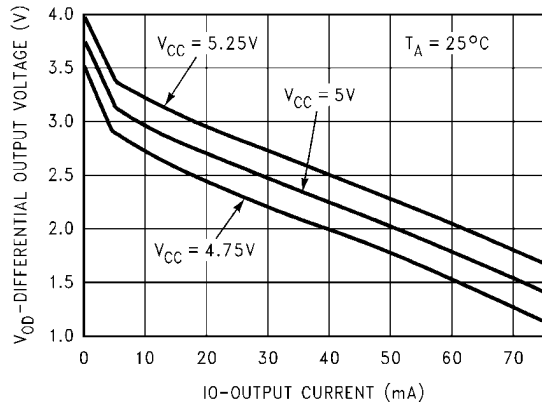

1138423

Driver  $V_{OH}$  vs  $I_{OH}$  vs  $V_{CC}$

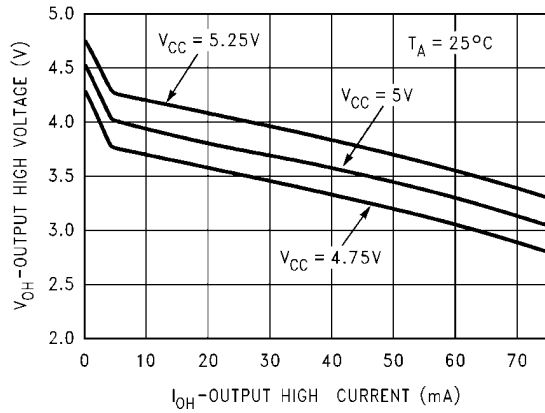

1138424

Driver  $V_{OH}$  vs  $I_{OH}$  vs Temperature

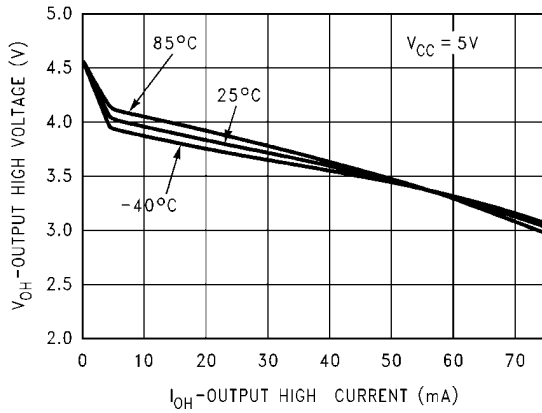

1138425

Driver  $V_{OL}$  vs  $I_{OL}$  vs  $V_{CC}$

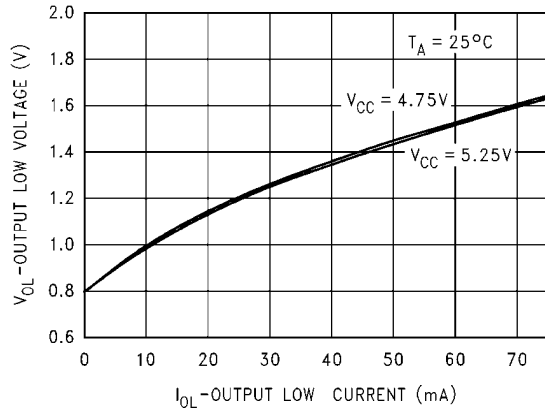

1138426

Driver  $V_{OL}$  vs  $I_{OL}$  vs Temperature

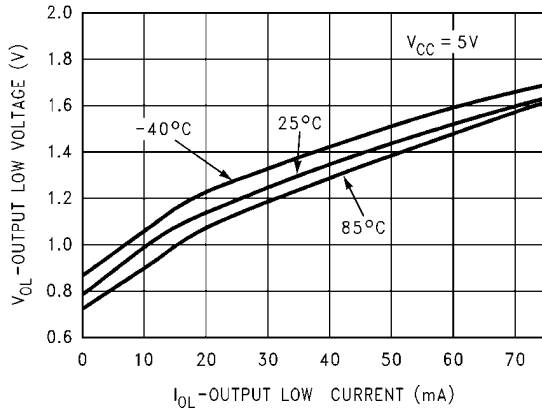

1138427

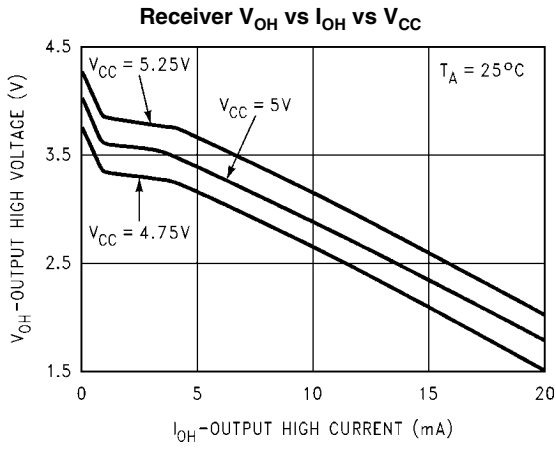

1138428

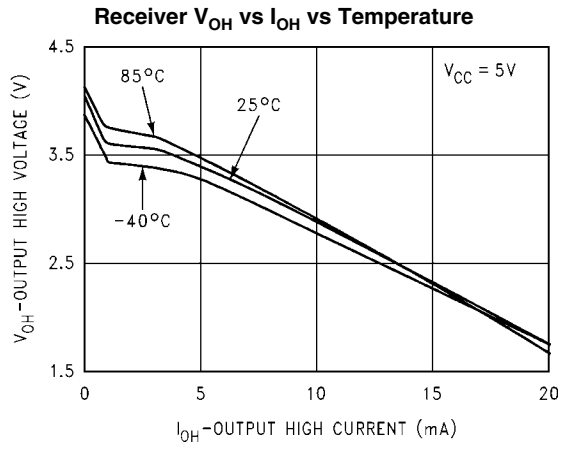

1138429

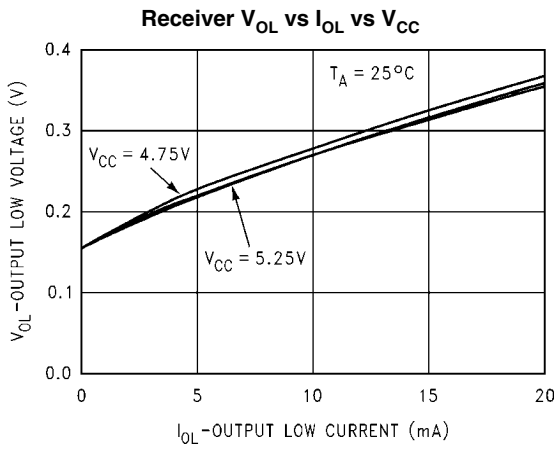

1138430

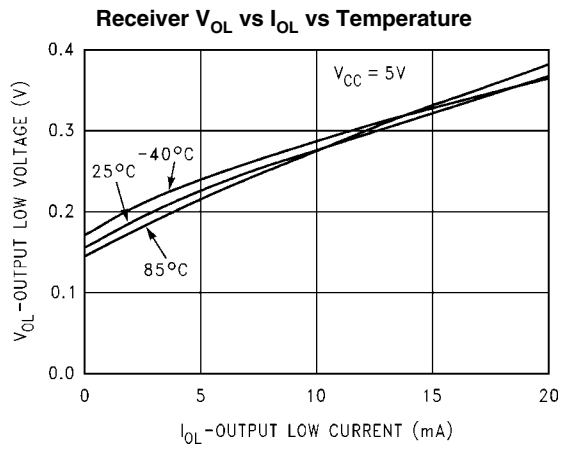

1138431

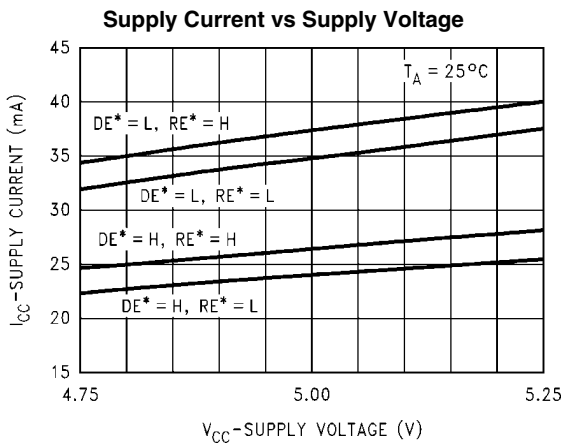

1138432

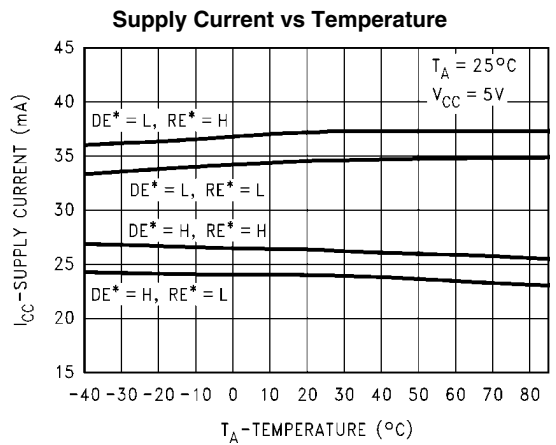

1138433

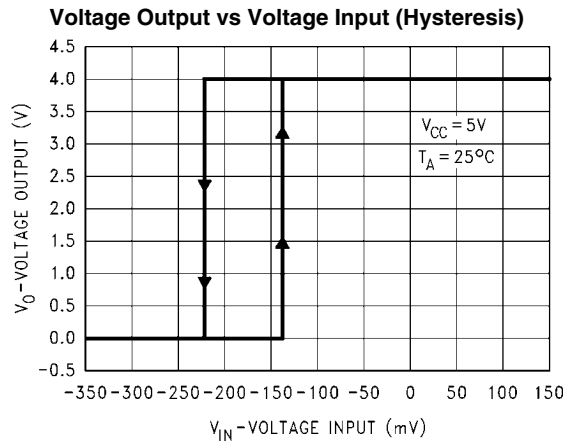

1138434

## Typical Applications Information

**SAE J1708 Node with External Bias Resistors and Filters**

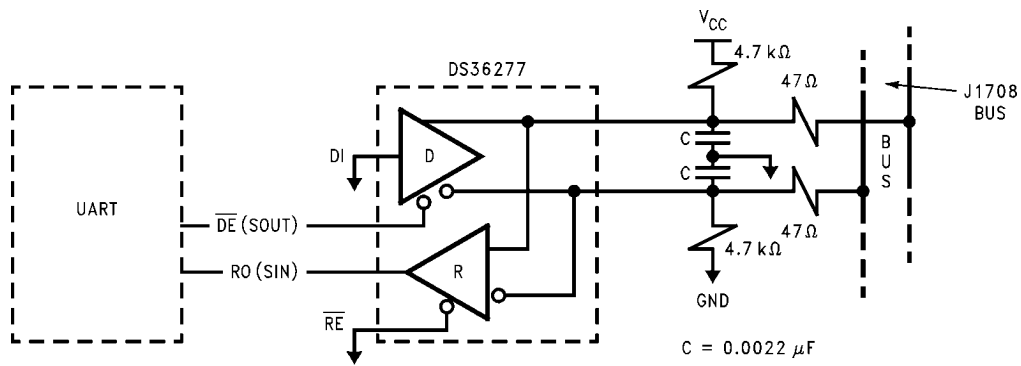

1138421

**Physical Dimensions** inches (millimeters) unless otherwise noted

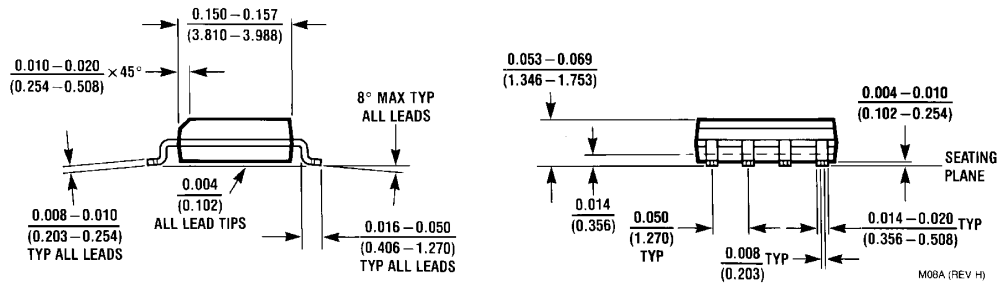
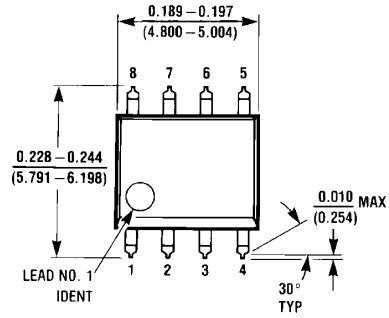

**8-Lead Molded Package (SO)**  
**Order Number DS36277TM**  
**NS Package Number M08A**

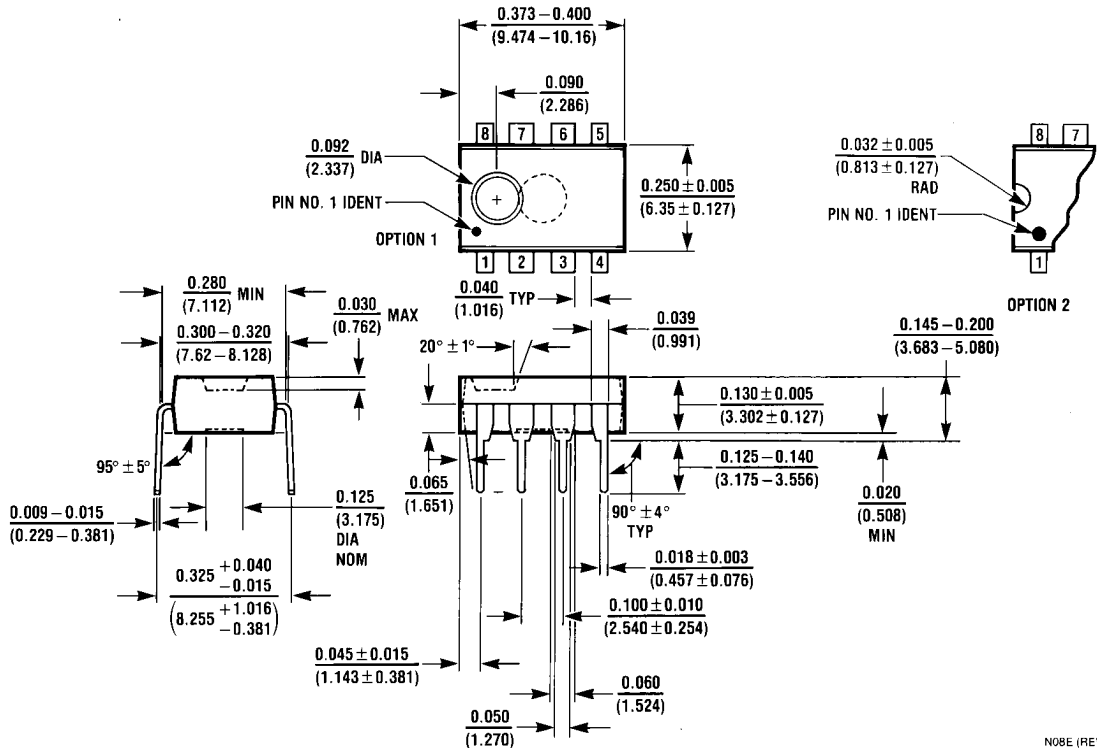

**8-Lead Molded Dual-In-Line Package (N)**  
**Order Number DS36277TN**  
**NS Package Number N08E**

# Notes

## Notes

For more National Semiconductor product information and proven design tools, visit the following Web sites at:

Products		Design Support	
Amplifiers	<a href="http://www.national.com/amplifiers">www.national.com/amplifiers</a>	WEBENCH	<a href="http://www.national.com/webench">www.national.com/webench</a>
Audio	<a href="http://www.national.com/audio">www.national.com/audio</a>	Analog University	<a href="http://www.national.com/AU">www.national.com/AU</a>
Clock Conditioners	<a href="http://www.national.com/timing">www.national.com/timing</a>	App Notes	<a href="http://www.national.com/appnotes">www.national.com/appnotes</a>
Data Converters	<a href="http://www.national.com/adc">www.national.com/adc</a>	Distributors	<a href="http://www.national.com/contacts">www.national.com/contacts</a>
Displays	<a href="http://www.national.com/displays">www.national.com/displays</a>	Green Compliance	<a href="http://www.national.com/quality/green">www.national.com/quality/green</a>
Ethernet	<a href="http://www.national.com/ethernet">www.national.com/ethernet</a>	Packaging	<a href="http://www.national.com/packaging">www.national.com/packaging</a>
Interface	<a href="http://www.national.com/interface">www.national.com/interface</a>	Quality and Reliability	<a href="http://www.national.com/quality">www.national.com/quality</a>
LVDS	<a href="http://www.national.com/lvds">www.national.com/lvds</a>	Reference Designs	<a href="http://www.national.com/refdesigns">www.national.com/refdesigns</a>
Power Management	<a href="http://www.national.com/power">www.national.com/power</a>	Feedback	<a href="http://www.national.com/feedback">www.national.com/feedback</a>
Switching Regulators	<a href="http://www.national.com/switchers">www.national.com/switchers</a>		
LDOs	<a href="http://www.national.com/lido">www.national.com/lido</a>		
LED Lighting	<a href="http://www.national.com/led">www.national.com/led</a>		
PowerWise	<a href="http://www.national.com/powerwise">www.national.com/powerwise</a>		
Serial Digital Interface (SDI)	<a href="http://www.national.com/sdi">www.national.com/sdi</a>		
Temperature Sensors	<a href="http://www.national.com/tempsensors">www.national.com/tempsensors</a>		
Wireless (PLL/VCO)	<a href="http://www.national.com/wireless">www.national.com/wireless</a>		

THE CONTENTS OF THIS DOCUMENT ARE PROVIDED IN CONNECTION WITH NATIONAL SEMICONDUCTOR CORPORATION ("NATIONAL") PRODUCTS. NATIONAL MAKES NO REPRESENTATIONS OR WARRANTIES WITH RESPECT TO THE ACCURACY OR COMPLETENESS OF THE CONTENTS OF THIS PUBLICATION AND RESERVES THE RIGHT TO MAKE CHANGES TO SPECIFICATIONS AND PRODUCT DESCRIPTIONS AT ANY TIME WITHOUT NOTICE. NO LICENSE, WHETHER EXPRESS, IMPLIED, ARISING BY ESTOPPEL OR OTHERWISE, TO ANY INTELLECTUAL PROPERTY RIGHTS IS GRANTED BY THIS DOCUMENT.

TESTING AND OTHER QUALITY CONTROLS ARE USED TO THE EXTENT NATIONAL DEEMS NECESSARY TO SUPPORT NATIONAL'S PRODUCT WARRANTY. EXCEPT WHERE MANDATED BY GOVERNMENT REQUIREMENTS, TESTING OF ALL PARAMETERS OF EACH PRODUCT IS NOT NECESSARILY PERFORMED. NATIONAL ASSUMES NO LIABILITY FOR APPLICATIONS ASSISTANCE OR BUYER PRODUCT DESIGN. BUYERS ARE RESPONSIBLE FOR THEIR PRODUCTS AND APPLICATIONS USING NATIONAL COMPONENTS. PRIOR TO USING OR DISTRIBUTING ANY PRODUCTS THAT INCLUDE NATIONAL COMPONENTS, BUYERS SHOULD PROVIDE ADEQUATE DESIGN, TESTING AND OPERATING SAFEGUARDS.

EXCEPT AS PROVIDED IN NATIONAL'S TERMS AND CONDITIONS OF SALE FOR SUCH PRODUCTS, NATIONAL ASSUMES NO LIABILITY WHATSOEVER, AND NATIONAL DISCLAIMS ANY EXPRESS OR IMPLIED WARRANTY RELATING TO THE SALE AND/OR USE OF NATIONAL PRODUCTS INCLUDING LIABILITY OR WARRANTIES RELATING TO FITNESS FOR A PARTICULAR PURPOSE, MERCHANTABILITY, OR INFRINGEMENT OF ANY PATENT, COPYRIGHT OR OTHER INTELLECTUAL PROPERTY RIGHT.

### LIFE SUPPORT POLICY

**NATIONAL'S PRODUCTS ARE NOT AUTHORIZED FOR USE AS CRITICAL COMPONENTS IN LIFE SUPPORT DEVICES OR SYSTEMS WITHOUT THE EXPRESS PRIOR WRITTEN APPROVAL OF THE CHIEF EXECUTIVE OFFICER AND GENERAL COUNSEL OF NATIONAL SEMICONDUCTOR CORPORATION.** As used herein:

Life support devices or systems are devices which (a) are intended for surgical implant into the body, or (b) support or sustain life and whose failure to perform when properly used in accordance with instructions for use provided in the labeling can be reasonably expected to result in a significant injury to the user. A critical component is any component in a life support device or system whose failure to perform can be reasonably expected to cause the failure of the life support device or system or to affect its safety or effectiveness.

National Semiconductor and the National Semiconductor logo are registered trademarks of National Semiconductor Corporation. All other brand or product names may be trademarks or registered trademarks of their respective holders.

Copyright© 2008 National Semiconductor Corporation

For the most current product information visit us at [www.national.com](http://www.national.com)



**National Semiconductor  
Americas Technical  
Support Center**  
Email: [support@nsc.com](mailto:support@nsc.com)  
Tel: 1-800-272-9959

**National Semiconductor Europe  
Technical Support Center**  
Email: [europe.support@nsc.com](mailto:europe.support@nsc.com)  
German Tel: +49 (0) 180 5010 771  
English Tel: +44 (0) 870 850 4288

**National Semiconductor Asia  
Pacific Technical Support Center**  
Email: [ap.support@nsc.com](mailto:ap.support@nsc.com)

**National Semiconductor Japan  
Technical Support Center**  
Email: [jpn.feedback@nsc.com](mailto:jpn.feedback@nsc.com)